



# **E32-433T20D User Manual**

**SX1278 433MHz 100mW TTL LoRa Wireless Module**



**CONTENT**

**DISCLAIMER AND COPYRIGHT NOTICE** ..... 3

**1 OVERVIEW** ..... 4

    1.1 PRODUCT INTRODUCTION .....4

    1.2 FEATURES .....4

    1.3 APPLICATION SCENARIOS ..... 4

**2 SPECIFICATIONS** ..... 4

    2.1 LIMIT PARAMETERS .....5

    2.2 WORKING PARAMETERS ..... 5

**3 MECHANICAL DIMENSIONS AND PIN DEFINITION** ..... 6

**4 RECOMMENDED WIRING DIAGRAM** ..... 7

**5 FUNCTION DETAILS** ..... 8

    5.1 FIXED - POINT TRANSMISSION (1 HEXADECIMAL ) .....8

    5.2 BROADCAST TRANSMISSION ( 1 HEXADECIMAL ) .....8

    5.3 BROADCAST ADDRESS ..... 9

    5.4 LISTENING ADDRESS ..... 9

    5.5 MODULE RESET ..... 9

    5.6 DETAILED AUX .....9

        5.6.1 *Serial port data output indication* ..... 9

        5.6.2 *Wireless transmission indication* ..... 10

        5.6.3 *The module is being configured* ..... 10

        5.6.4 *AUX Notes* ..... 10

**6 WORKING MODE** ..... 12

    6.1 MODE SWITCH .....12

    6.2 GENERAL MODE (MODE 0) .....13

    6.3 WAKE -UP MODE (MODE 1) .....13

    6.4 POWER SAVING MODE (MODE 2) .....13

    6.5 SLEEP MODE (MODE 3) ..... 14

**7 COMMAND FORMAT** ..... 14

    7.1 FACTORY DEFAULT PARAMETERS .....14

    7.2 READING OF WORKING PARAMETERS ..... 14

    7.3 VERSION NUMBER READ .....14

    7.4 RESET COMMAND ..... 15

    7.5 PARAMETER SETTING INSTRUCTIONS .....15

**8 HARDWARE DESIGN** ..... 17

**9 FREQUENTLY ASKED QUESTIONS** ..... 18

    9.1 THE TRANSMISSION DISTANCE IS NOT IDEAL .....18

    9.2 MODULES ARE EASILY DAMAGED ..... 18

---

9.3 BIT ERROR RATE IS TOO HIGH .....	18
<b>10 WELDING OPERATION INSTRUCTIONS .....</b>	<b>18</b>
<b>11 RELATED MODELS .....</b>	<b>19</b>
<b>12 ANTENNA GUIDELINES .....</b>	<b>19</b>
12.1 _ ANTENNA RECOMMENDATION .....	19
<b>13 BULK PACKAGING METHOD .....</b>	<b>20</b>
<b>REVISE HISTORY .....</b>	<b>21</b>
<b>ABOUT US .....</b>	<b>21</b>

## Disclaimer and Copyright Notice

Information in this document, including URL addresses for reference, is subject to change without notice. Documentation is provided "as is" without warranty of any kind, including any warranties of merchantability, fitness for a particular purpose, or non-infringement, and any warranties referred to elsewhere in any proposal, specification or sample. No responsibility is assumed in this document, including any liability for infringement of any patent rights arising out of the use of the information in this document. This document does not hereby grant, by estoppel or otherwise, any license, express or implied, to use any intellectual property rights.

The test data obtained in this article are all obtained by the Ebyte laboratory test, and the actual results may be slightly different. All trade names, trademarks and registered trademarks mentioned herein are the property of their respective owners and are hereby acknowledged.

Final interpretation right belongs to Chengdu Ebyte Electronic Technology Co., Ltd.

Note :

Due to product version upgrade or other reasons, the contents of this manual may be changed. Ebyte Electronic Technology Co., Ltd. reserves the right to modify the contents of this manual without any notice or prompt. This manual is only used as a guide. Chengdu Ebyte Electronic Technology Co., Ltd. does its best to provide accurate information in this manual. However, Chengdu Ebyte Electronic Technology Co., Ltd. does not ensure that the contents of the manual are completely error-free. All statements in this manual , information and advice do not create any express or implied warranties.

# 1 Overview

## 1.1 Product introduction

E32-433T20D is a wireless serial port module (TTL level) based on Semtech's SX1278 radio frequency chip, transparent transmission, working in the 410-441MHz frequency band (default 433MHz), using LoRa spread spectrum technology.

SX1278 supports LoRa spread spectrum technology. LoRa direct sequence spread spectrum technology has the advantages of longer communication distance, strong anti-interference ability, and strong confidentiality. SX1278 is a milestone in the field of low-speed communication, and is favored by people in the industry. The default air rate of this series is 2.4kbps, the transmit power is 20dBm, and the industrial-grade crystal oscillator is used to ensure its stability and consistency, and the accuracy is less than 10ppm, which is generally used in the industry. At present, it has been in stable mass production, and has been widely used in the three-meter industry, Internet of Things transformation, smart furniture and other fields. The module has data encryption and compression functions. The data transmitted by the module in the air is random, and the data interception is meaningless through strict encryption and decryption algorithms. The data compression function has the possibility to reduce the transmission time, reduce the probability of being interfered, and improve reliability and transmission efficiency.

E32-433T20D strictly abides by FCC, CE, CCC and other domestic and foreign design specifications, meets various RF-related certifications, and meets export requirements.

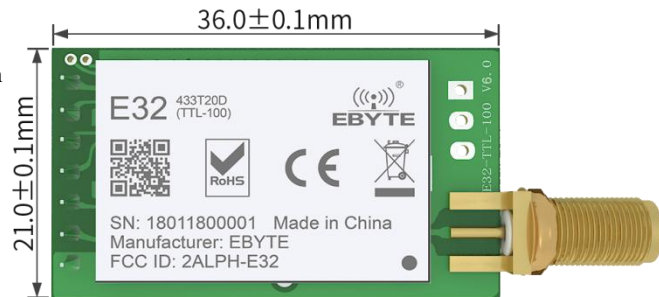

## 1.2 Features

- Support advanced LoRa modulation, with the advantage of long-distance anti-interference;
- Under ideal conditions, the communication distance can reach 3km, and the transmission distance is better than that of traditional GFSK;
- Support fixed-point transmission, broadcast transmission, channel monitoring;
- Support air wake-up (ultra-low power consumption), suitable for battery applications;
- Support FEC forward error correction to improve communication stability;
- maximum transmit power is 100mW, and the software is multi-level adjustable;
- Support global license-free ISM 433MHz frequency band;
- Support data transmission rate of 0.3k~19.2kbps;
- Support 2.3 ~ 5.5 V power supply, more than 3.3V power supply can ensure the best performance;
- Industrial-grade standard design, support long-term use at -40 ~ +85 °C;
- SMA-K interface for easy connection of coaxial cable or external antenna.

## 1.3 Application scenarios

- Home security alarm and remote keyless entry;
- Smart home and industrial sensors, etc.;
- Wireless alarm security system;
- Building automation solutions;
- Wireless industrial grade remote control;
- Intelligent intelligent agriculture, oilfield solutions;

- healthcare products;
- Advanced Meter Reading Architecture (AMI);
- Automotive industry applications.

## 2 Specifications

### 2.1 Limit parameters

The main parameters	performance		Remark
	minimum	maximum value	
Supply voltage (V)	0	5.5	More than 5.2V will permanently burn the module
Blocking power (dBm)	-	- 10	The probability of burning at close range is small
Working temperature ( °C )	-40	+ 85	Industrial grade

### 2.2 Working parameters

The main parameters	performance			Remark
	minimum	Typical value	maximum value	
Working voltage (V)	2.3 _	5.0	5.5 _	≥ 3.3 V guaranteed output power
Communication level (V)		3.3 _		Risk of burnout with 5V TTL
Working temperature ( °C )	-40	-	+ 85	Industrial grade design
Working frequency band ( M Hz)	4 10	-	4 41	Support ISM frequency band , factory default 4 33MHz
Power consumption	Emission current (mA)	1 1 0		Instantaneous power consumption
	Receive current (mA)		1 4	
	Sleep current (μA)		4	software shutdown
Maximum transmit power (dBm)	19.0 _ _	-	20.0 _	
Receive Sensitivity (dBm)	-144	-146	-147	The air rate is 2.4kbps
Air rate (bps)	0.3k _	2.4k	19.2k _	User self-configured

The main parameters	describe	Remark
reference distance	3000m	Clear and open, antenna gain 5dBi, antenna height 2.5m, air rate 2.4kbps
Subcontracting	5 8B tye	The maximum capacity of a single package, it will be automatically sub-packaged when it exceeds.
Cache capacity	5 12B tye	
Modulation	LoRa™	
Communication Interface	UART serial port	TTL level
Packaging method	- line	
interface	1* 7 * 2.54mm	
Dimensions	2 1 * 36mm	
Antenna interface	SMA-K	Characteristic impedance about 50 Ω

### 3 Mechanical Dimensions and Pin Definition

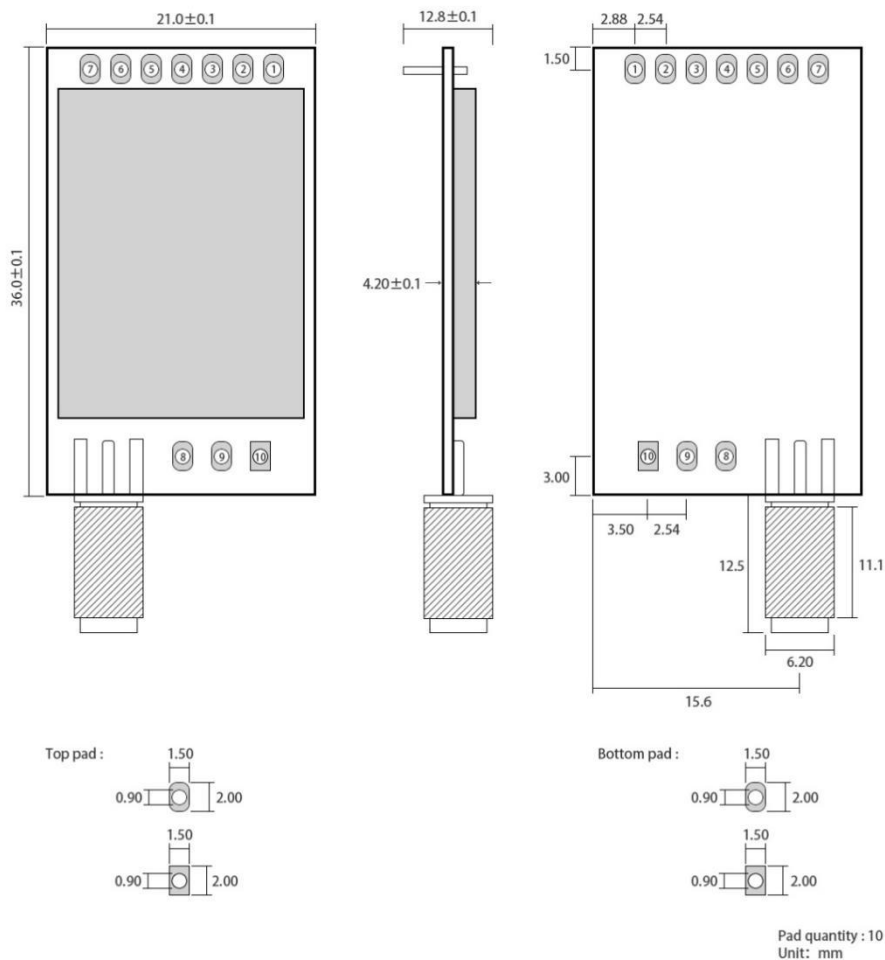

pin number	pin name	Pin Orientation	pin usage
1	M0	Input (very weak pull-up)	Cooperate with M1 to determine the 4 working modes of the module. <b>(Cannot be left floating, can be grounded if not used)</b>
2	M1	Input (very weak pull-up)	Cooperate with M0 to determine 4 working modes of the module. <b>(Cannot be left floating, can be grounded if not used)</b>
3	RXD	enter	TTL serial port input, connected to the external TXD output pin; Can be configured as open-drain or pull-up input, see parameter settings for details.
4	TXD	output	TTL serial output, connected to external RXD input pin; Can be configured as open-drain or push-pull output, see parameter settings for details.
5	AUX	output	Used to indicate the working status of the module; <b>(can be left floating)</b> The user wakes up the external MCU, and outputs a low level during the power-on self-test initialization; It can be configured as open-drain output or push-pull output, see parameter settings for details.
6	VCC	enter	Positive reference for module power supply, voltage range: 2.3 to 5.5 V DC
7	GND	enter	Module ground
8	fixing hole		fixing hole
9	fixing hole		fixing hole
10	fixing hole		fixing hole

## 4 Recommended Wiring Diagram

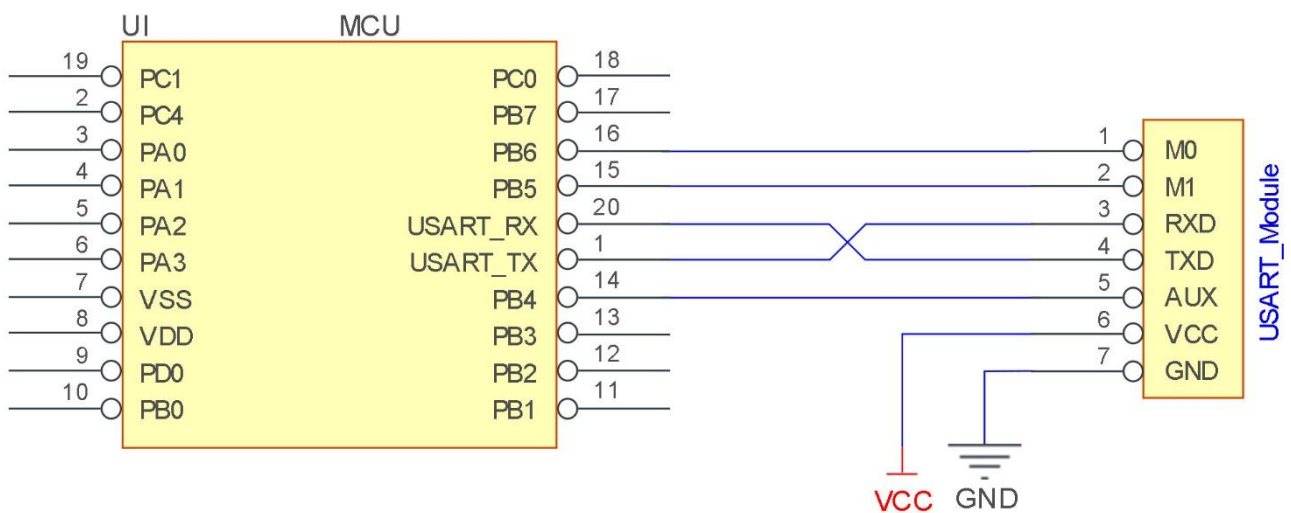



serial number	A brief description of the connection between the module and the microcontroller (the above picture takes the STM8L microcontroller as an example)
1	The wireless serial port module is TTL level, please connect with TTL level MCU.
2	Some 5V microcontrollers may need to add 4 ~ 10K pull-up resistors to the TXD and AUX pins of the module.

## 5 Function Details

### 5.1 Fixed - point transmission ( 1 hexadecimal )

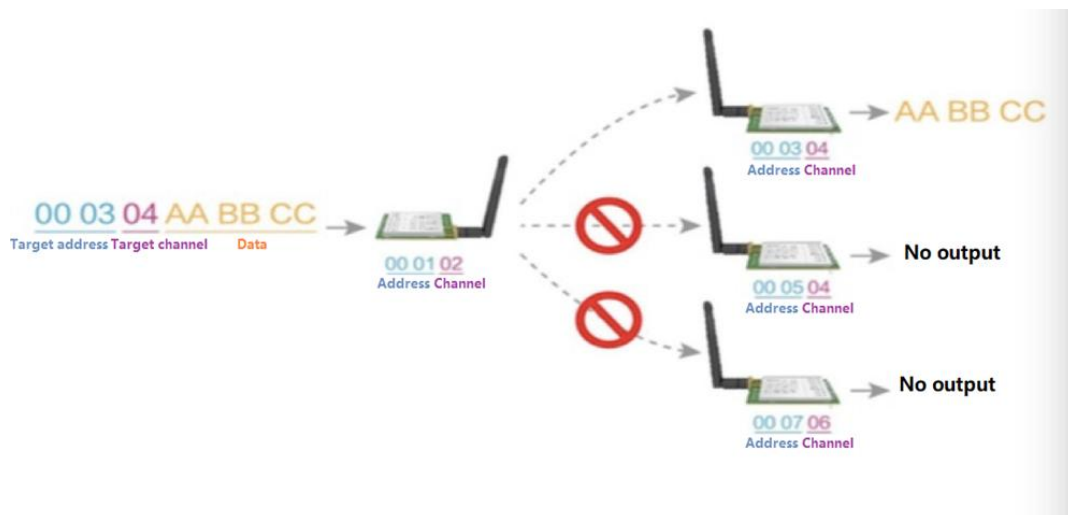

### 5.2 Broadcast transmission ( 1 hexadecimal )



### 5.3 Broadcast address

- Example: Set the module A address to 0xFFFF and the channel to 0x04.
- When module A is used as a transmitter (same mode, transparent transmission mode), all receiving modules under the 0x04 channel can receive data to achieve the purpose of broadcasting.

### 5.4 Listening address

- Example: Set the module A address to 0xFFFF and the channel to 0x04.
- When module A is used as a receiver, it can receive all the data under the 0x04 channel to achieve the purpose of monitoring.

### 5.5 Module reset

- After the module is powered on, AUX will output a low level immediately, perform hardware self-test, and set the working mode according to user parameters. During this process, the AUX keeps the low level, and after the completion, the AUX outputs the high level, and starts to work normally according to the working mode formed by the combination of M1 and M0. Therefore, the user needs to wait for the rising edge of AUX as the starting point for the normal operation of the module.

### 5.6 Detailed AUX

- AUX is used for wireless transceiver buffer indication and self-check indication.
- It indicates whether the module has data that has not been transmitted wirelessly, or whether the wireless data has been received and not all sent through the serial port, or the module is in the process of initializing and self-checking.

#### 5.6.1 Serial port data output indication

- Used to wake up the external MCU in sleep ;

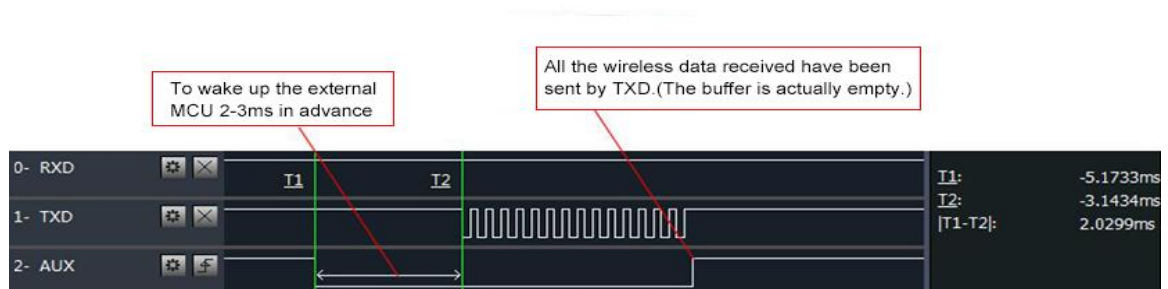

Timing Sequence Diagram of AUX when TXD pin transmits

### 5.6.2 Wireless transmission indication

- Buffer empty: The data in the internal 512-byte buffer is written to the wireless chip (automatic sub-packet).
- When AUX=1, the user continuously initiates data less than 512 bytes without overflow. When AUX=0, the buffer is not empty: the data in the internal 512-byte buffer has not been written to the wireless chip and the transmission is started. At this time, the module may be waiting for the end of the user data to time out, or the wireless packet transmission is in progress. .
- [Note]: When AUX=1, it does not mean that all serial port data of the module has been transmitted wirelessly, or the last packet of data may be being transmitted.

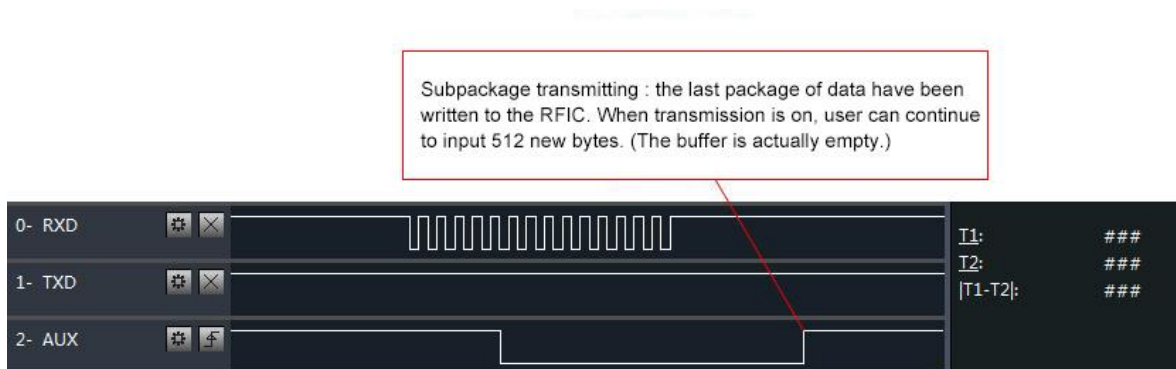

Timing Sequence Diagram of AUX when RXD pin receives

### 5.6.3 The module is being configured

- Only at reset and when exiting sleep mode



Timing Sequence Diagram of AUX when self-check

### 5.6.4 AUX Notes

- For the above functions 1 and 2, the output low level is given priority, that is, if any one of the output low level conditions is satisfied, the AUX outputs the low level; when all the low level conditions are not satisfied, the AUX outputs the high level.
- When AUX outputs a low level, it means that the module is busy, and the working mode detection will not be performed at this time; when the module AUX outputs a high level within 1ms, the mode switching work will be completed.
- After the user switches to the new working mode, the module will enter this mode at least 2ms after the rising edge of AUX; if AUX is always at a high level, the mode switching will take effect immediately.
- When the user enters other modes from mode 3 (sleep mode) or during the reset process, the module will reset the user parameters, during which AUX outputs a low level.

- Due to the characteristics of the LoRa modulation method, the information transmission delay is much longer than that of FSK. For example, at 1.2kbps airspeed, the transmission delay of 100 bytes is about 1.5 seconds. It is recommended that customers do not transmit large amounts of data at low airspeeds. , so as not to cause communication exceptions due to data loss caused by data accumulation.

## 6 Working Mode

The module has four working modes, which are controlled by pins M 0, M 1 Settings; details are shown in the table below:

mode (0-3)	M0	M1	Mode introduction	Remark
0 Normal mode	0	0	Serial port open, wireless open, transparent transmission	Receiver must be mode 0, 1
1 Wake-up mode	1	0	Serial port open, wireless open; The only difference from mode 0: before the data packet is transmitted, the wake-up code is automatically added, so as to wake up the receiver working in mode 2	Receiver can be mode 0 The receiver can be mode 1 The receiver can be mode 2
2 Power saving mode	0	1	The serial port receiving is closed, and the wireless is in the air wake-up mode. After receiving the wireless data, open the serial port to send data.	Transmitter must be Mode 1 Can't launch in this mode
3 Sleep Mode	1	1	The module goes to sleep and can receive parameter setting commands	For details, please refer to the detailed explanation of working parameters.

### 6.1 Mode switch

- Users can combine M0 and M1 with high and low levels to determine the working mode of the module. 2 GPIOs of MCU can be used to control mode switching; ,

When M0 and M1 are changed: the module is idle, and after 1ms, it can start to work according to the new mode;

If the module has serial port data that has not been transmitted wirelessly, the new working mode can only be entered after the transmission is completed;

If the module receives wireless data and sends out data through the serial port, it needs to be sent to the new working mode;

Therefore, the mode switching can only be effective when the AUX output is 1, otherwise the switching will be delayed.
- For example: in mode 0 or mode 1, if the user continuously inputs a large amount of data and switches modes at the same time, the mode switching operation is invalid at this time;

The module will only perform new mode detection after processing all user data;

So the general suggestion is: Detect the output state of the AUX pin, wait for 2ms after the AUX output high level, and then switch.
- When the module is switched from other modes to sleep mode, if there is data that has not been processed;

The module can only enter sleep mode after processing these data (including receiving and sending);

This feature can be used for fast sleep to save power consumption; for example: the transmitter module works in mode 0, the user initiates serial port data "12345", and then does not need to wait for the AUX pin to be idle (high level), and can directly switch to sleep mode, The main MCU of the user is put to sleep immediately, and the module will automatically go to sleep within 1ms after sending all the user data wirelessly, thereby saving the working time of the MCU and reducing power consumption.
- Similarly, any mode switching can use this feature. After the module processes the current mode event, it will automatically enter the new mode within 1ms;

This saves the user's work of querying AUX, and can achieve the purpose of fast switching;

For example, switching from the transmit mode to the receive mode; the user MCU can also go to sleep in advance before the

mode switch, and use the external interrupt function to obtain the AUX change to perform the mode switch.

- This operation mode is very flexible and efficient, and is completely designed according to the user's MCU operation convenience, and can reduce the workload of the entire system as much as possible, improve system efficiency, and reduce power consumption.

## 6.2 General Mode (Mode 0)

type	When M0 = 0, M1 = 0, the module works in mode 0
emission	The module receives user data from the serial port, and the length of the wireless data packet transmitted by the module is 58 bytes. When the amount of data input by the user reaches 58 bytes, the module will start wireless transmission. At this time, the user can continue to input the data to be transmitted; when the user needs When the transmitted bytes are less than 58 bytes, the module waits for 3 bytes. If no user data continues to be input, the data is considered to be terminated. At this time, the module sends all data packets wirelessly; when the module receives the first user data , the AUX output is low level, when the module puts all the data into the RF chip and starts the transmission, the AUX output is high level; at this time, it indicates that the last packet of wireless data has been started to transmit, and the user can continue to input up to 512 Byte data; data packets sent through mode 0 can only be received by the receiving module in mode 0 and mode 1.
take over	The module has always turned on the wireless receiving function, and can receive data packets from mode 0 and mode 1; After receiving the data packet, the module AUX outputs low level, and after a delay of 5ms, it starts to send wireless data through the serial port TXD pin. After all wireless data is output through the serial port, the module outputs AUX high level.

## 6.3 Wake -up Mode (Mode 1)

type	When M0 = 1, M1 = 0, the module works in mode 1
emission	The conditions for the module to start data packet transmission and the AUX function are equivalent to mode 0; the only difference is that the module will automatically add a wake-up code before each data packet, and the length of the wake-up code depends on the wake-up time set in the user parameters; the wake-up code The purpose is to wake up the receiving module working in mode 2; therefore, the data transmitted in mode 1 can be received by modes 0, 1, and 2.
take over	Equivalent to mode 0.

## 6.4 Power saving mode (mode 2)

type	When M0 = 0, M1 = 1, the module works in mode 2
emission	The module is in a dormant state, the serial port is closed, and it cannot receive serial port data from an external MCU, so this mode does not have a wireless transmission function.
take over	In mode 2, the transmitter is required to work in mode 1; monitor the wake-up code regularly, once a valid wake-up code is received, the module will continue to be in the receiving state and wait for the entire valid data packet to be received; then AUX outputs a low level , after a delay of 5ms, open the serial port to send the received wireless data through TXD, and output AUX high level after completion; the wireless module continues to enter the "sleep-monitoring" working state (polling); by setting different wake-up times, the module With different receiving response delay (maximum 2s) and average power consumption (minimum 30uA); users need to achieve a balance between communication delay time and average power consumption.

## 6.5 Sleep Mode (Mode 3)

type	When M0 = 1, M1 = 1, the module works in mode 3
emission	Unable to transmit wireless data.
take over	Unable to receive wireless data.
configure	Sleep mode can be used for module parameter setting, use serial port 9600, 8N1, and set module working parameters through specific command format.
Notice	When entering other modes from sleep mode, the module will reconfigure parameters. During the configuration process, AUX remains low level; after completion, it outputs high level, so it is recommended that users detect the rising edge of AUX.

## 7 Command Format

In sleep mode (mode 3: M0=1, M1=1), the list of supported commands is as follows (when setting, only 9600 and 8N1 formats are supported):

serial number	Instruction format	Detailed description
1	C0+ working parameters	Send C0+5 bytes working parameters in hexadecimal format, a total of 6 bytes, must be sent continuously (power-off save)
2	C1+C1+C1	Send three C1s in hexadecimal format, and the module returns the saved parameters, which must be sent continuously.
3	C2+ working parameters	Send C2+5 bytes working parameters in hexadecimal format , a total of 6 bytes, must be sent continuously (not saved when power off)
4	C3+C3+C3	Three C3s are sent in hexadecimal format, and the module returns version information, which must be sent continuously.
5	C4+C4+C4	Send three C4s in hexadecimal format, the module will generate a reset and must be sent continuously.

### 7.1 Factory default parameters

model	Factory default parameter value: C0 00 00 1A 17 40						
Module model	frequency	address	channel	air rate	baud rate	Serial format	transmit power
E32-433T20D	433MHz	0x0000	0x17	2.4kbps	9600	8N1	100mW

### 7.2 Reading of working parameters

Instruction format	Detailed description
C1+C1+C1	In sleep mode (M0=1, M1=1), send a command (HEX format) to the module serial port: C1 C1 C1, The module will return the current configuration parameters, for example: C0 00 00 1A 17 44.

### 7.3 version number read

Instruction format	Detailed description
--------------------	----------------------

C3+C3+C3	<p>In sleep mode (M0=1, M1=1), issue a command (HEX format) to the module serial port: C3 C3 C3,                  The module returns the current configuration parameters, such as: C3 32 XX YY;                  C3 is the command prefix, 32 represents the product model, XX represents the version number, and YY represents the interface format + the maximum power value of the module (hexadecimal). The TTL interface is 0x10, RS232 is 0x40, and RS485 is 0x80</p>
----------	--

## 7.4 Reset command

Instruction format	Detailed description
C4+C4+C4	<p>In sleep mode (M0=1, M1=1), send a command to the module serial port (HEX format): C4 C4 C4,                  The module will generate a reset;                  During the reset process, the module conducts self-check, and AUX outputs a low level. After the reset is completed, AUX outputs a high level and the module starts to work normally;                  At this point, a mode switch can be performed or the next instruction can be initiated.</p>

## 7.5 Parameter setting instructions

	name	describe	Remark			
0	HEAD	Fixed 0xC0 or 0xC2, indicating that this frame data is a control command	Must be 0xC0 or C2 C0: The set parameters will be saved after power off. C2: The set parameters will not be saved after power off.			
1	ADDH	Module address high byte (default 00H)	00H-FFH			
2	ADDL	Module address low byte (default 00H)	00H-FFH			
3	SPED	7	6	Serial check digit	The serial port modes of both sides of the communication can be different	
		0	0	8N1 (default)		
		0	1	8O1		
		1	0	8E1		
		1	1	8N1 (equivalent to 00)		
		5	4	3	TTL serial port rate (bps)	The baud rate of both sides of the communication can be different. The baud rate of the serial port has nothing to do with the wireless transmission parameters, and does not affect the wireless transceiver characteristics.
		0	0	0	Serial port baud rate is 1200	
		0	0	1	Serial port baud rate is 2400	
		0	1	0	Serial port baud rate is 4800	
		0	1	1	Serial port baud rate is 9600 (default)	
		1	0	0	Serial port baud rate is 19200	
		1	0	1	Serial port baud rate is 38400	
		1	1	0	Serial port baud rate is 57600	
		1	1	1	Serial port baud rate is 115200	
		2	1	0	Common Wireless Air Rate (bps)	The lower the air rate, the longer the distance, the stronger the anti-jamming performance and the longer the transmission time. The air wireless transmission rate of both parties must be the same.
		0	0	0	Air rate is 0.3k	
		0	0	1	Air rate is 1.2k	
		0	1	0	Air rate is 2.4k (default)	
		0	1	1	Air rate is 4.8k	
1	0	0	Air rate is 9.6k			
1	0	1	Air rate is 19.2k			
1	1	0	The air rate is 19.2k (same as 101)			
1	1	1	The air rate is 19.2k (same as 101)			
4	CHAN	Universal model				
		7	6	5	keep unused	Write 0.



		communication channel				00H-1FH, corresponding to 410~441MHz			
		4~ 0 , corresponding to (410MHz+CHAN * 1 MHz), default 17H (433MHz)							
5	OPTION	7	Fixed-point transmit enable bit (like MODBUS)			When it is 1, the first 3 bytes of each user data frame are used as high and low addresses and channels. When transmitting, the module changes its own address and channel, and after completion, restores the original settings.			
		0	Transparent Transmission Mode						
		1	Fixed point transmission mode						
		6	IO drive mode (default 1)			This bit is used to enable the module's internal pull-up resistor. Open-drain mode has better level adaptability, and external pull-up resistors may be required in some cases			
		1	TXD, AUX push-pull output, RXD pull-up input						
		0	TXD, AUX open circuit output, RXD open circuit input			<p>The transceiver modules all work in mode 0, and the delay time is invalid and can be any value.</p> <p>The transmitter works in mode 1 and will continue to transmit the call code for the corresponding time.</p> <p>The receiver works in mode 2, and this time refers to the monitoring interval (wireless wake-up) of the receiver, and can only receive data from the transmitter working in mode 1.</p>			
		5	4	3	Wireless wake-up time				
		0	0	0	250ms (default)				
		0	0	1	500ms				
		0	1	0	750ms				
		0	1	1	1000ms				
		1	0	0	1250ms				
		1	0	1	1500ms				
		1	1	0	1750ms				
		1	1	1	2000ms				
		2	FEC switch			After FEC is turned off, the actual data transmission rate is increased, but the anti-interference ability is weakened, and the distance is slightly shorter. Please select it according to the actual application; Both communication parties must be on or both off.			
		0	Turn off FEC error correction						
		1	Turn on FEC error correction (default)						
1	0	Transmit power (approximate value)		<p>The external power supply must provide more than 250mA current output capability. And ensure that the power supply ripple is less than 100mV ;</p> <p>It is not recommended to use low power transmission, and its power utilization efficiency is not high.</p>					
0	0	20dBm (default)							
0	1	17dBm							
1	0	14dBm							
1	1	10dBm							
<b>For example (the meaning of the serial number 3 "SPED" byte):</b>									
the binary bit of the byte		7	6	5	4	3	2	1	0
Specific value (user configuration)		0	0	0	1	1	0	1	0
representative meaning		Serial check bit 8N1		Serial port baud rate is 9600			Air rate is 2.4k		
corresponding hexadecimal		1				A			

## 8 Hardware Design

- It is recommended to use a DC regulated power supply to supply power to the module, the power supply ripple coefficient should be as small as possible, and the module should be reliably grounded;
- Please pay attention to the correct connection of the positive and negative poles of the power supply, such as reverse connection may cause permanent damage to the module;
- Please check the power supply to ensure that it is between the recommended supply voltages, if exceeding the maximum value will cause permanent damage to the module;
- Please check the stability of the power supply, the voltage should not fluctuate greatly and frequently;
- When designing the power supply circuit for the module, it is often recommended to reserve more than 30% of the margin, so that the whole machine can work stably for a long time;
- The module should be kept away from parts with large electromagnetic interference such as power supply, transformer, and high-frequency wiring as far as possible;
- High-frequency digital traces, high-frequency analog traces, and power traces must be avoided under the module. If it is absolutely necessary to pass under the module, assuming that the module is soldered on the Top Layer, the top layer of the contact part of the module should be covered with ground copper (all copper). And well grounded, it must be close to the digital part of the module and routed on the Bottom Layer ;
- Assuming that the module is soldered or placed on the Top Layer, it is also wrong to arbitrarily route wires on the Bottom Layer or other layers, which will affect the stray and receiving sensitivity of the module to varying degrees ;
- Assuming that there are devices with large electromagnetic interference around the module, it will also greatly affect the performance of the module. It is recommended to stay away from the module according to the strength of the interference. If the situation allows, appropriate isolation and shielding can be done;
- Assuming that there are traces with large electromagnetic interference around the module (high-frequency digital, high-frequency analog, power traces), it will also greatly affect the performance of the module. It is recommended to stay away from the module according to the intensity of the interference. isolation and shielding;
- If the communication line uses 5V level, a 1k-5.1k resistor must be connected in series (not recommended, there is still a risk of damage) ;
- Try to stay away from some TTL protocols whose physical layer is also 2.4GHz, for example: USB3.0;
- The antenna installation structure has a great influence on the performance of the module, and it is necessary to ensure that the antenna is exposed and preferably vertically upward;
- When the module is installed inside the casing, a high-quality antenna extension cable can be used to extend the antenna to the outside of the casing;
- The antenna must not be installed inside the metal shell, which will greatly reduce the transmission distance.

## 9 Frequently Asked Questions

### 9.1 The transmission distance is not ideal

- When there is a straight-line communication obstacle, the communication distance will be correspondingly attenuated ;
- Temperature, humidity, and co-channel interference will increase the communication packet loss rate ;
- The ground absorbs and reflects radio waves, and the test effect close to the ground is poor ;
- Seawater has a strong ability to absorb radio waves, so the seaside test effect is poor ;
- If there is a metal object near the antenna, or placed in a metal shell, the signal attenuation will be very serious ;
- The power register is set incorrectly, and the air speed is set too high (the higher the air speed, the closer the distance) ;
- The low voltage of the power supply at room temperature is lower than the recommended value, and the lower the voltage, the lower the output power ;
- The antenna and the module are poorly matched or the quality of the antenna itself is a problem.

### 9.2 Modules are easily damaged

- Please check the power supply to ensure that it is between the recommended supply voltages, if exceeding the maximum value will cause permanent damage to the module ;
- Please check the stability of the power supply, the voltage should not fluctuate greatly and frequently ;
- Please ensure anti-static operation during installation and use, and high-frequency components are electrostatically sensitive ;
- Please ensure that the humidity during installation and use should not be too high, and some components are humidity-sensitive devices ;
- If there is no special requirement, it is not recommended to use it at too high or too low temperature.

### 9.3 Bit error rate is too high

- There is co-frequency signal interference nearby, stay away from the interference source or modify the frequency and channel to avoid interference;
- If the power supply is not ideal, it may also cause garbled characters. Be sure to ensure the reliability of the power supply;
- Poor quality or too long extension cables and feeders can also cause high bit error rates.

## 10 Welding Operation Instructions

This product is a direct plug-in module. When welding the module, the welding personnel must work in accordance with the electrostatic discharge operation specifications;

This product is a static-sensitive product, and the module may be permanently damaged if it is not welded according to the specification.

## 11 Related Models

Product number	carrier frequency Hz	transmit power dBm	Test distance km	air speed bps	Package form	Product size mm	Antenna form
<a href="#">E32-170T30D</a>	170M	30	8	0.3k ~ 9.6k	Straight plug	24 * 43	SMA-K
<a href="#">E32-433T20D</a>	433M	20	3	0.3k ~ 19.2k	Straight plug	21 * 36	SMA-K
<a href="#">E32-400T20S</a>	433/470M	20	3	0.3k ~ 19.2k	patch	16 * 26	IPEX/stamp hole
<a href="#">E32-433T30D</a>	433M	30	8	0.3k ~ 19.2k	Straight plug	24 * 43	SMA-K
<a href="#">E32-433T30S</a>	433M	30	8	0.3k ~ 19.2k	patch	25 * 40.3	IPEX/stamp hole
<a href="#">E32-900T20D</a>	862~930M	20	3	0.3k ~ 19.2k	Straight plug	21 * 36	SMA-K
<a href="#">E32-900T20S</a>	862~930M	20	3	0.3k ~ 19.2k	patch	16 * 26	IPEX/stamp hole
<a href="#">E32-900T30D</a>	862~930M	30	8	0.3k ~ 19.2k	Straight plug	24 * 43	SMA-K
<a href="#">E32-900T30S</a>	862~930M	30	8	0.3k ~ 19.2k	patch	25 * 40.3	IPEX/stamp hole

## 12 Antenna Guidelines

### 12.1 Antenna recommendation

Antennas play an important role in the communication process, and often inferior antennas will have a great impact on the communication system. Therefore, our company recommends some antennas as antennas with excellent performance and reasonable price for our wireless modules.

Product number	type	frequency band	gain	size	feeder	interface	Features
		Hz	dB	mm	cm		
<a href="#">TX433-NP-4310</a>	flexible antenna	433M	2.0	10x43	-	welding	Flexible FPC Soft Antenna
<a href="#">TX433-JZ-5</a>	glue stick antenna	433M	2.0	52	-	SMA-J	Ultra-short straight, omnidirectional antenna
<a href="#">TX433-JZG-6</a>	glue stick antenna	433M	2.5	62	-	SMA-J	Ultra-short straight, omnidirectional antenna

<a href="#">T X433-JW-5</a>	glue stick antenna	433M	2.0_	50	-	SMA-J	Fixed bent , omnidirectional antenna
<a href="#">T X433-JWG-7</a>	glue stick antenna	433M	2.5_	70	-	SMA-J	Fixed bent , omnidirectional antenna
<a href="#">T X433-JK-11</a>	glue stick antenna	433M	2.5_	110	-	SMA-J	Bendable glue stick , omnidirectional antenna
<a href="#">T X433-JK-20</a>	glue stick antenna	433M	3.0	200	-	SMA-J	Bendable glue stick , omnidirectional antenna
<a href="#">T X433-XPL-100</a>	sucker antenna	433M	3.5	185	100	SMA-J	Small suction cup antenna , cost -effective
<a href="#">T X433-XP-200</a>	sucker antenna	433M	4.0	190	200	SMA-J	Small suction cup antenna , low loss
<a href="#">T X433-XP-300</a>	sucker antenna	433M	6.0_	965	300	SMA-J	Small suction cup antenna , high gain

### 13 Bulk Packaging Method

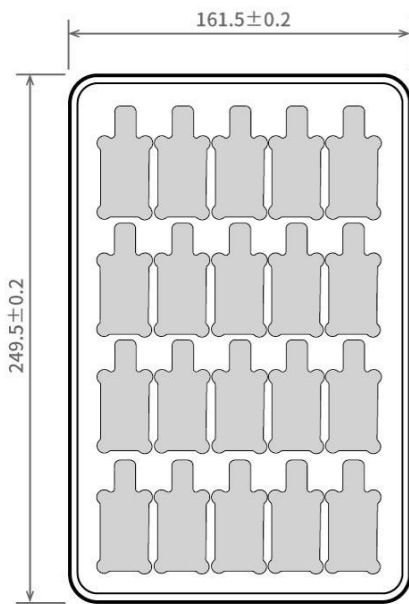

Unit: mm  
 Each Layer: 20 pcs  
 Each Package: 5 layers

## Revise history

Version	revision date	Revision Notes	Maintenance man
1.0	2022-5-12	initial version	Yan

## About us

Technical support: [support@cdebyte.com](mailto:support@cdebyte.com)

Documents and RF Setting download link: [www.ebyte.com](http://www.ebyte.com)

Thank you for using Ebyte products! Please contact us with any questions or suggestions: [info@cdebyte.com](mailto:info@cdebyte.com)

Fax: 028-64146160

Web: [www.ebyte.com](http://www.ebyte.com)

Address: B5 Mould Industrial Park, 199# Xiqu Ave, High tech Zone, Chengdu, Sichuan, China



**Chengdu Ebyte Electronic Technology Co.,Ltd.**