







YSD20L SERIES 20W



Yingjiao's slimline power family are designed with slim plastic housing and for full range AC input from 90V AC TO 264V AC. The series are single phase PSU, providing DC OK relay contact and adjustable DC output voltage. They have high efficiency and operate in wide temperature range. The series can widely used for industrial automation & control systems, varied equipments etc.

   RoHS

Features

-  Universal AC Input/ Full Range
-  DC OK Signal Output
-  Protection: Short Circuit/Overload/ Over Voltage/Over Temperature
-  Installation on DIN Rail TS-35/7.5 & 15
-  DC Output Voltage Adjustable
-  Three Years Warranty

Model Information

Yingjiao Part number	DC VOLTAGE	RATED CURRENT	RATED POWER
YSD20L-0503000	5V	3A	15W
YSD20L-1201670	12V	1.37A	20W
YSD20L-1501340	15V	1.34A	20W
YSD20L-2401000	24V	1A	24W

Input

VOLTAGE RANGE	85-264VAC/120-370VDC	
FREQUENCY RANGE	50/60Hz	
INRUSH CURRENT	35A/115VAC 70A/230VAC	
AC CURRENT	0.33A/115VAC 0.21A/230VAC	
LEAKAGE CURRENT	<0.25mA/240VAC	
EFFICIENCY	76%	YSD20L-0503000
	80%	YSD20L-1201670
	81%	YSD20L-1501340
	84%	YSD20L-2401000

Output

RIPPLE & NOISE	80mVp-p	YSD20L-0503000
	120mVp-p	YSD20L-1201670
	120mVp-p	YSD20L-1501340
	150mVp-p	YSD20L-2401000
VOLTAGE TOLERANCE	± 5.0%	
LINE REGULATION	± 1.0%	
LOAD REGULATION	± 5.0%	
SETUP, RISE TIME	500ms, 30ms/230VAC at full load 1000ms, 30ms/115VAC at full load	

Protection

OVER LOAD	>105%-150% Rated Output Power Protection type: Hiccup Mode- recovers automatically after fault condition is removed
OVER VOLTAGE	5V:5.75~ 6.75V 12V:13.8 ~ 16.2V 15V:17.25 ~ 20.25V 24V:27.6 ~ 32.4V Protection type : Shut down o/p voltage, re-power on to recover
OVER TEMPERATURE	Shut down o/p voltage, re-power on to recover
OVER CURRENT	110%-180%

Environment

OPERATING TEMPERATURE	-20 °C to 60 °C , Full Load, Normal Operation
STORAGE TEMP	-40 °C to 85 °C
STORAGE HUMIDITY	10 ~ 95% RH
WORKING HUMIDITY	20% ~ 95% RH Non-Condensing
MTBF	200,000 Hours Minimum at Full Load at 25 °C Ambient

SAFETY & EMC

SAFETY REGULATIONS	UL508, UL1310 , BS/EN62368-1 approved
WITHSTAND VOLTAGE	I/P-O/P:3KVAC I/P-FG:2KVAC O/P-FG:0.5KVAC
ISOLATION RESISTANCE	I/P-O/P, I/P-FG, O/P-FG:100M Ohms / 500VDC / 25 °C / 70% RH
EMC EMISSION	Compliance to BS EN/EN55032 (CISPR32), BS EN/EN61204-3 Class B, BS EN/EN61000- 3-2,-3, EAC TP TC 020, CNS13438 Class B

Dimensions & Weight

Length:	23mm / 0.91in
Width:	100mm / 3.94in
Height:	92mm / 3.62in
Weight:	150g

Packing

Carton Size:	54 x 30 x 24 CM 21.26 x 11.81 x 9.45 in
Master Carton Quantities:	100pcs / Carton

Dimensions and Installation

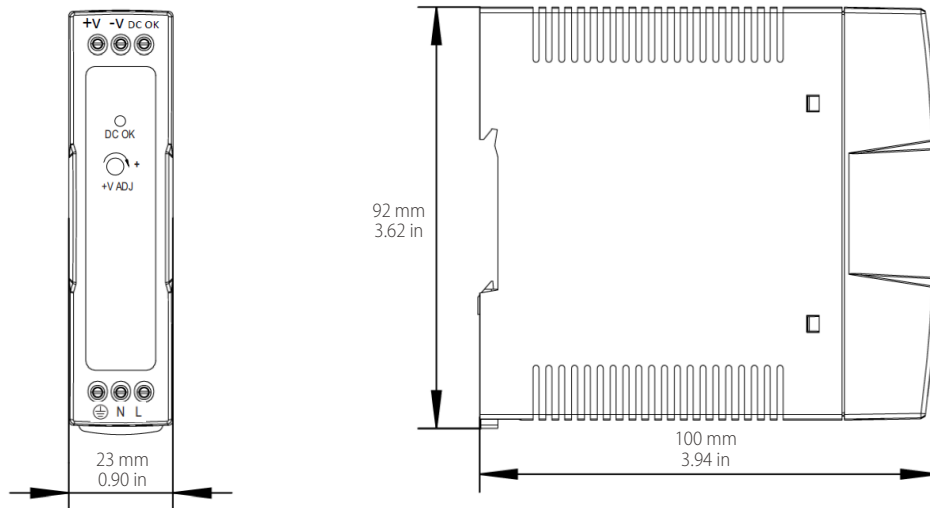

Functional Diagram

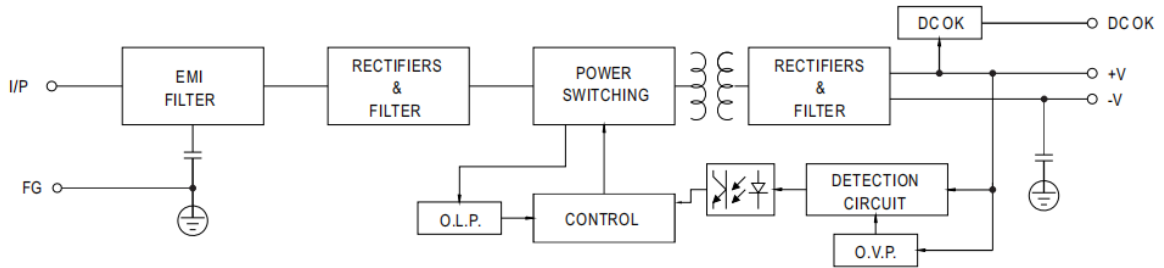

Application of DC OK Active Signal

(a) 5V signal

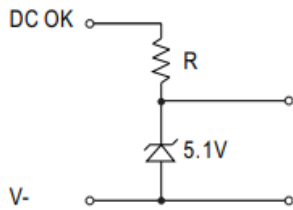

Model	R
5V	$\geq 200\ \Omega$
12V	$\geq 1.5K\ \Omega$
15V	$\geq 2K\ \Omega$
24V	$\geq 3.9K\ \Omega$

(b) LED

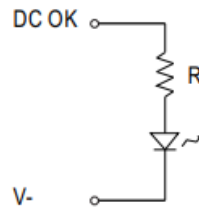

Model	R
5V	$\geq 1K\ \Omega$
12V	$\geq 2.4K\ \Omega$
15V	$\geq 3K\ \Omega$
24V	$\geq 4.7K\ \Omega$

(c) Relay

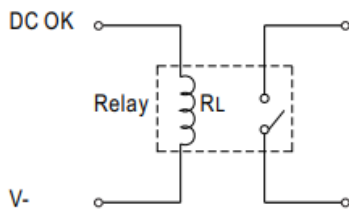

Model	RL
5V	$\geq 120\ \Omega$
12V	$\geq 700\ \Omega$
15V	$\geq 700\ \Omega$
24V	$\geq 1.2K\ \Omega$

Deduction curve and temperature

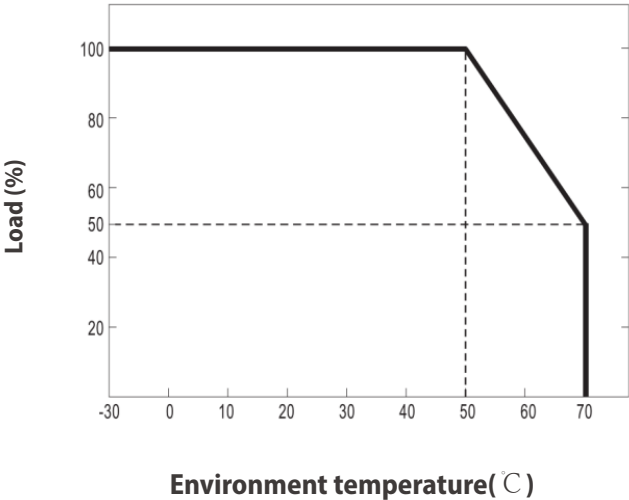

Minus output and input voltage curves

