

Crystal oscillator

SMD CMOS Output 7.0×5.0×1.3mm 6N Series



Approved by: 刘惠光

Checked by : 李相同

Issued by: 贺丹斌

SPECIFICATION

PN: ECN-6N24000M3C045ZA3

深圳市晶科鑫实业有限公司

SHENZHEN CRYSTAL TECHNOLOGY INDUSTRIAL CO., LTD.

Add: 12F, Bldg. 3C, TianAn Cloud Park Phase 1, Bantian, Longgang, Shenzhen, China

Tel: (86) 755 88352809 88352810

Fax: (86) 755 88353718 88352499

E-mail: SJK_William@q-crystal.com

[HTTP://www.q-crystal.com](http://www.q-crystal.com)

Page 1

Crystal oscillator

SMD CMOS Output 7.0×5.0×1.3mm 6N Series



FEATURE

- Small SMD seam sealed clock crystal oscillator units.
- High precision characteristic covering up to wide frequency range.
- Designed for automatic mounting and reflow soldering.
- Tri-State function available.
- Supply voltage range : 1.8 V ~ 5.0 V.
- High stability, low jitter, low power consumption.
- Main application : wireless communication set, PC, and LCDM.
- RoHS Compliant / Pb Free.

ELECTRICAL SPECIFICATIONS (电气参数)

Parmeters	Condition\Model	6N
Fan Out Type		CMOS
Supply Voltage		3.3V±10%
Frequency		24.000MHz
Operating Temperature		-40°C to +85°C
Current		20mA max
Frequency Stability	All Conditions	±50ppm
Output Voltage	Vol(max)	10%VDD
	VoH(min)	90%VDD
Rise/Fall Time	AT 0.1Vdd~0.9Vdd	5ns max
Load Capacitance		15pF
Duty Cycle		50±10%
Storage Temperature		-55~+125°C
Start-upTime	Load RANGE	5mSec max
Aging		±3ppm(1st ,year at 25 °C)
Tri-State	Output Active	2.31V Min Pin 1 Tri-state
	Output in High-Impedance	0.99V Max
PAD Connection	PIN#1 Tri-State/NC	PIN#3 OUT
	PIN#2 GND	PIN#4 Vdd

Add: 12F, Bldg. 3C, TianAn Cloud Park Phase 1, Bantian, Longgang, Shenzhen, China

Tel: (86) 755 88352809 88352810

Fax: (86) 755 88353718 88352499

E-mail: SJK_William@q-crystal.com

HTTP://www.q-crystal.com

Page 2

Crystal oscillator

SMD CMOS Output 7.0×5.0×1.3mm 6N Series



Dimension (尺寸) (Unit: mm)

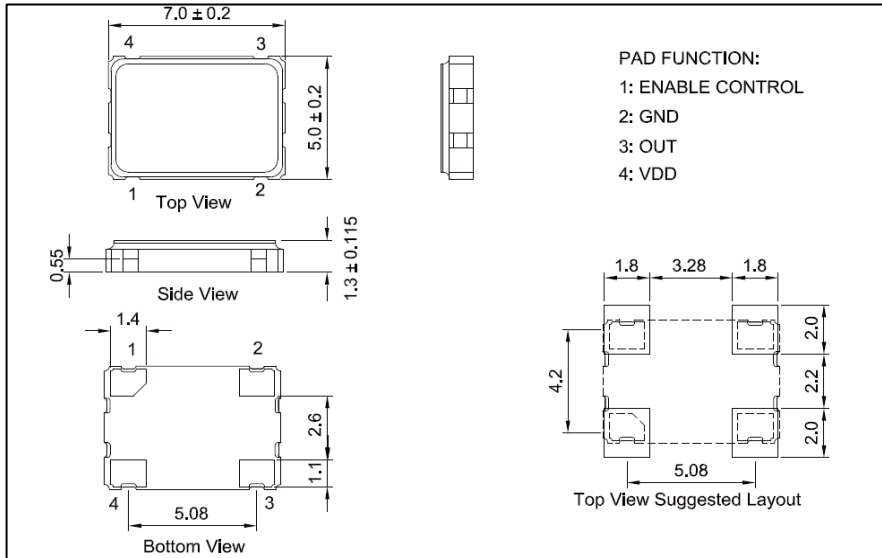

MEASUREMENT CIRCUIT (电路)

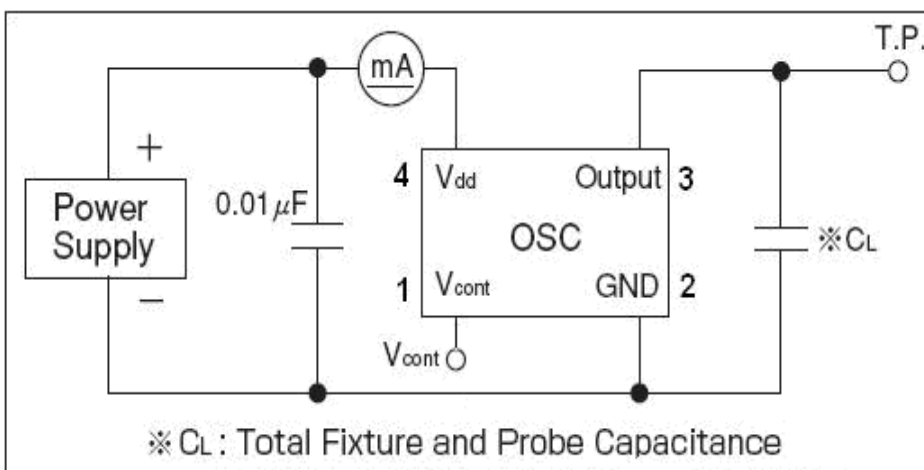

Crystal oscillator

SMD CMOS Output 7.0×5.0×1.3mm 6N Series



WAVEFORM CONDITIONS (波形)

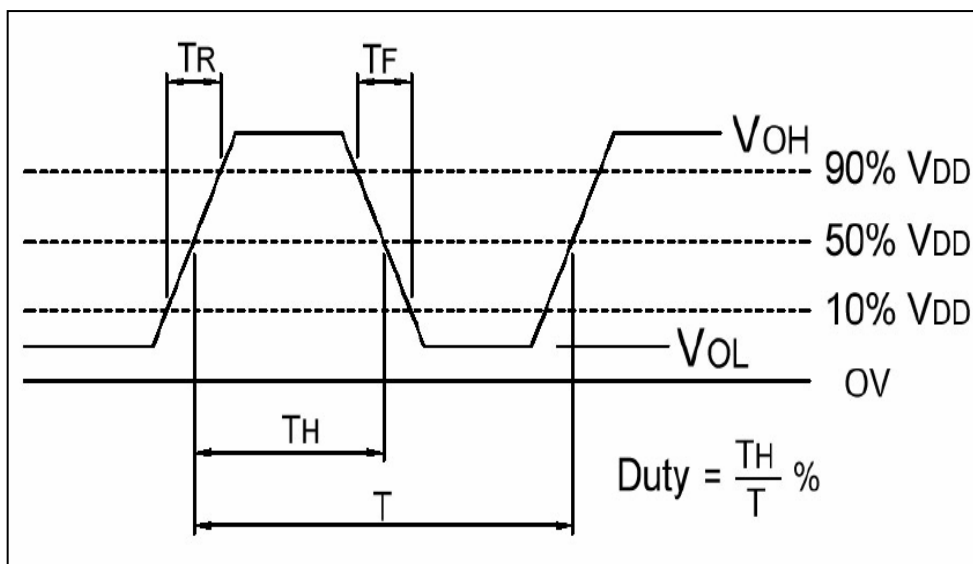

REFLOW CONDITION (回流焊)

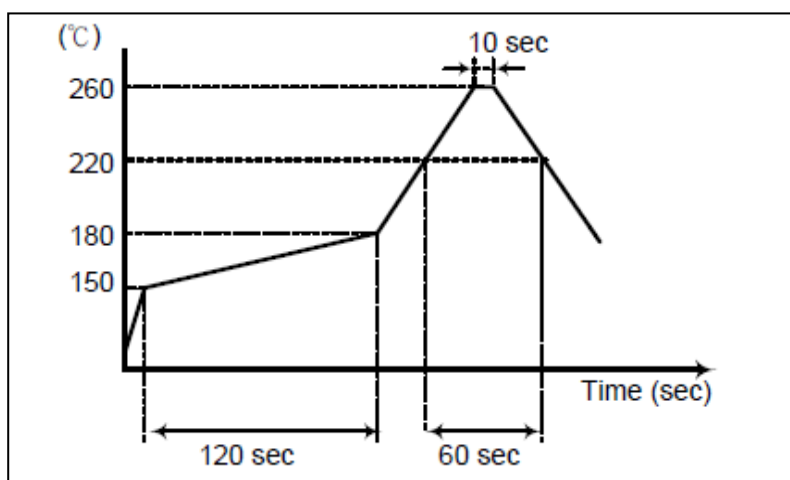

The reflow temperature profile may vary depending on the product model, specifications and frequency range. Refer to the individual product specifications for details

Crystal oscillator

SMD CMOS Output 7.0×5.0×1.3mm 6N Series



CARRIER TYPE (载带)

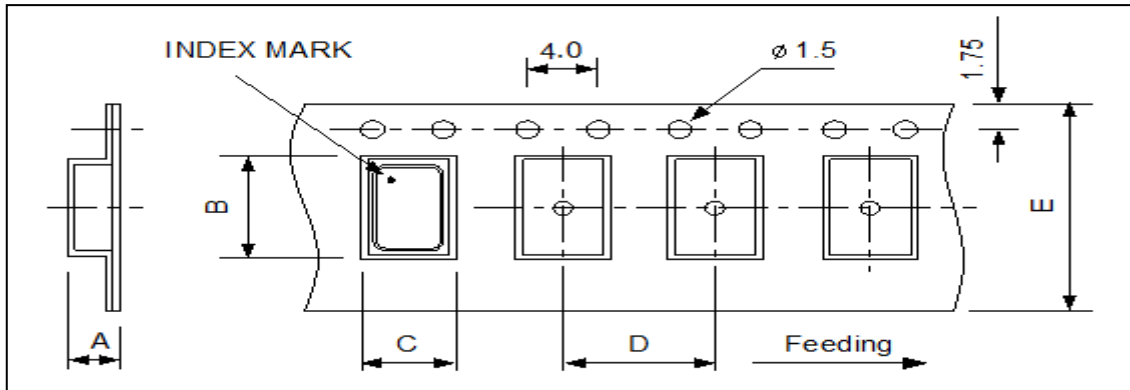

REEL(卷盘)

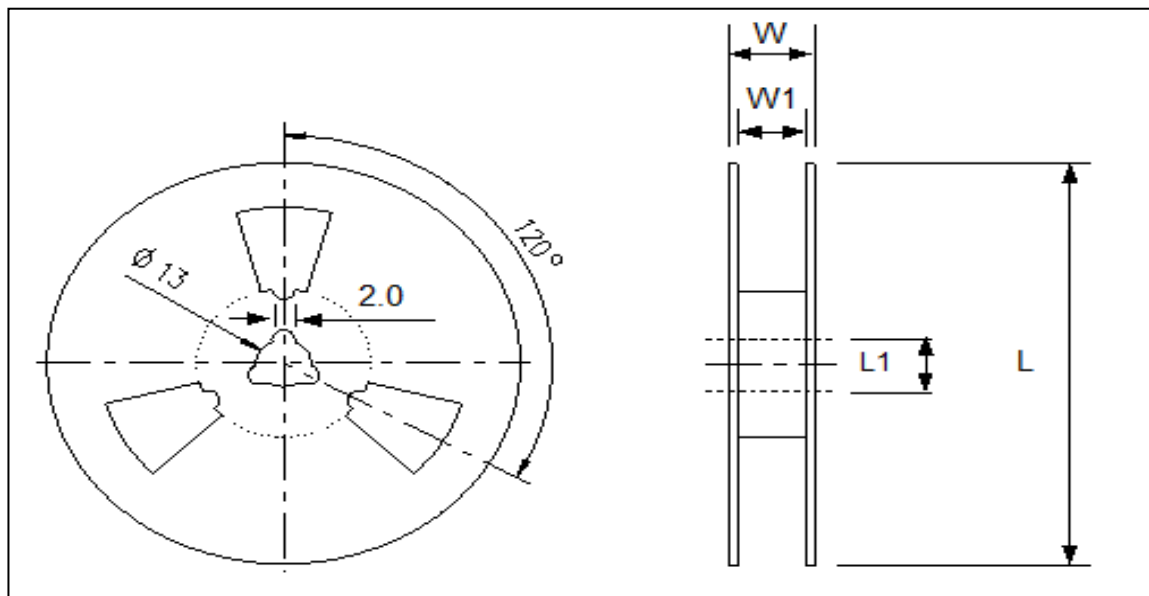

DIMENSIONS		A	B	C	D	E	L	L1	W	W1	pcs / Reel
	7050	2.15	7.9	5.4	8	16	180	13	21.5	17.5	1K
	6035	1.4	6.4	3.9	8	12	180	13	15.4	13	1K
	5032	1.46	5.5	3.6	8	12	180	13	15.4	13	1K
	3225	1.4	3.4	2.7	4	8	180	13	11.5	8	3K
	2520	1.15	2.8	2.25	4	8	180	13	10.5	8	3K
	2016	0.95	2.25	2.25	4	8	180	13	10.5	9	3K
	1612	0.8	2.0	1.85	4	8	180	13	10.5	9	3K

Crystal oscillator

SMD CMOS Output 7.0×5.0×1.3mm 6N Series



Crystal oscillator

SMD CMOS Output 7.0×5.0×1.3mm 6N Series



RELIABILITY TEST SPECIFICATIONS (可靠性测试标准)

Test item	Equipment	Condition	Specification
1.SOLDERABILITY TEST	SJK-REL001、RC-328A	1.Solderability:235±5℃, 5±0.5S 2.Heat resistance:260±5℃,10±1S restoration of 1 hour	MIL-STD-883E Method 2003.7
2. HERMETICITY TEST	HELIOT-306S	FC-84 FLUOROCARBON,BUBBLE MACHINE	MIL-STD-883E Method 1014.10
3. VIBRATION TEST	HG-V4、 S&A 250B	Enable Crystal(10g) from 10-55-10Hz,X、 Y、 Z horizontal,1 Minute vibration/time, 1time/ 2 hours.	MIL-STD-883E Method 2007.3
4. MECHANICAL SHOCK	HPC-200、 S&A 250B	Enable Crystal 50G(490m/s ²) time=11 ms speed=3.4 m/s half sine wave oscillation	JIS C6701
5. DROP TEST	HARD BOARD.S&A250B	75CM HIGH,3 TIMES ON HARD BOARD	MIL-STD-202F Method 213B
6. HIGH&LOW TEMP STORAGE TEST(Static test)	H-PTH-80CK & HM101-3ABN, S&A 350B/250B	High temperature: 125℃±2℃,1000hr; Low temperature:-40℃±3℃,1000hrs	MIL-STD883C, METHOD 1011.8
7. TEMP &HUM CYCLING TEST	H-PTH-80CK CHAMBE, S&A 350B/250B	Temperature:-10℃±2℃~65℃±2℃,Humidity:93±3%,1 cycle need 24 hrs. 5cycles.	MIL-STD-883E Method 1005.8
8. HIGH TEM. & HUM. STORAGE TEST	H-PTH-80CK CHAMBE, S&A350B/250B	Temperature:40℃±2, Humidity:85+3,-2%,Store 96 hrs	JIS C6701
9.AGING TEST	H-PTH-80CK CHAMBE, S&A350B/250	Temperature:40℃±2, Humidity:85+3,-2%,Store 96 hrs	JIS C5023

Add: 12F, Bldg. 3C, TianAn Cloud Park Phase 1, Bantian, Longgang, Shenzhen, China

Tel: (86) 755 88352809 88352810

Fax: (86) 755 88353718 88352499

E-mail: SJK_William@q-crystal.com

HTTP://www.q-crystal.com

Page 6